













HUESCA







77 3,7 325 106 150 608x313x303 64 13

Caratteristiche

- Sistema Doppia Combustione
- Sistema di Vetro Pulito
- Potenza di riscaldamento: 13kw
- Rendimento (%): 77%
- Consumo (kg/h): 3,7kg/h
- Volume riscaldabile (m3): 325m3
- Interni vermiculite
- Fatto in fundizione e acciaio
- Peso (Kg): 106kg
- Diametro di uscita di fumi (mm): 150mm
- Le misure della bocca utile della camera: 608x313x303mm
- Massima misura tronchi (cm): 64cm

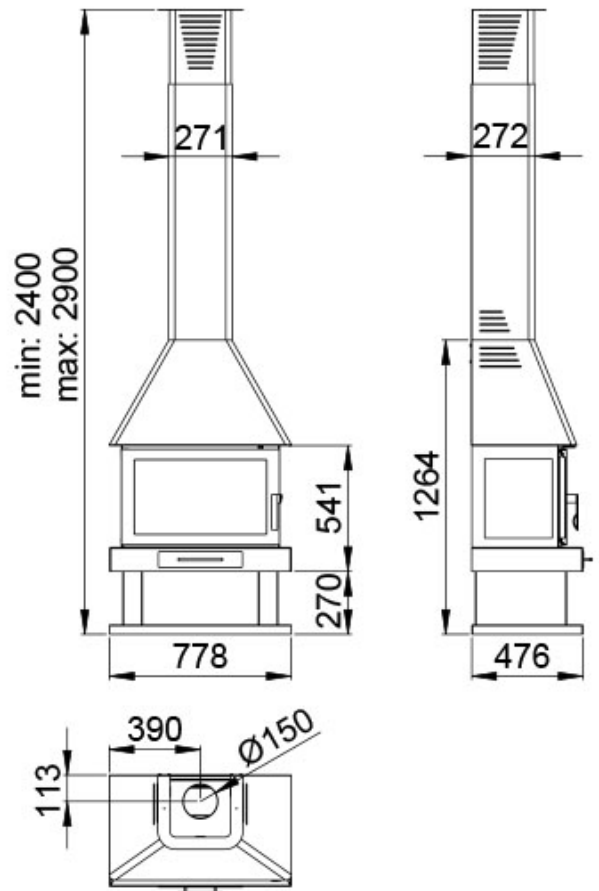

Dato il continuo miglioramento dei nostri prodotti e migliorare il nostro processo di produzione, dimensioni, estetica e le specifiche dei prodotti sono soggette a modifiche senza preavviso da parte nostra azienda.

www.bronpi.com

