

# VERSALLES-C













© Bronpi Calefacción, S.L. si riserva tutti i diritti per le immagini che appaiono in questo documento. Non è possibile riprodurre o distribuire tutto o in parte le fotografie e come il testo. Sia il brand come segni distintivi sono di proprietà esclusiva della Società. I trasgressori saranno perseguiti a norma di legge.



la excelencia en el fuego



la excelencia en el fuego

 12	 75	 3,5	 300			 154	 150		 580x306x286
 55									

## Caratteristiche

- Potenza di riscaldamento: 12kw
- Rendimento (%): 75%
- Consumo (kg/h): 3,5 kg/h
- Volume riscaldabile (m3): 300m3
- Interno di fundizione
- Fatto in fundizione e scheda
- Ventilazione forzata (n° x m3): 1x290
- Peso (Kg): 154kg
- Diametro di uscita di fumi (mm): 150mm
- Sistema di pulizia vetro pullito
- Le misure della bocca utile della camera: 580x306x286mm
- Massima misura tronchi (cm): 55cm

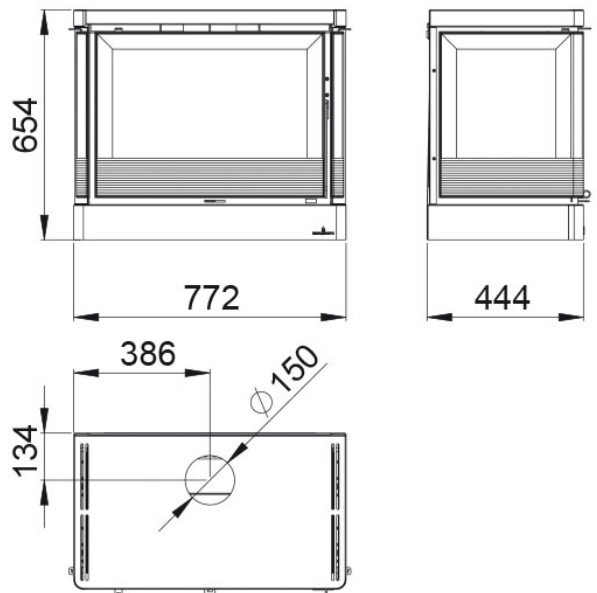

Dato il continuo miglioramento dei nostri prodotti e migliorare il nostro processo di produzione, dimensioni, estetica e le specifiche dei prodotti sono soggette a modifiche senza preavviso da parte nostra azienda.

[www.bronpi.com](http://www.bronpi.com)

